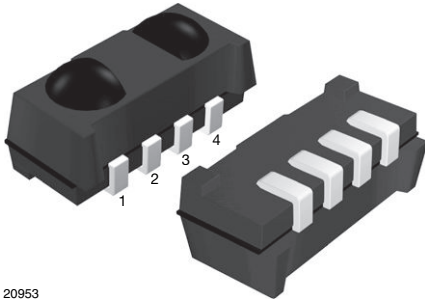


## IR Receiver Modules for 3D Synchronization Signals



20953

### MECHANICAL DATA

#### Pinning:

1, 4 = GND, 2 =  $V_S$ , 3 = OUT

### FEATURES

- Compliant to proposed CEA-2038 for long command encoding
- Command driven IR synchronized active eyewear standard
- Center frequency at 26.2 kHz to reduce interference with IR remote control signals at 30 kHz to 56 kHz
- Package can be used with IR emitters with wavelength 830 nm as well as standard 940 nm
- Very low supply current and stand-by mode
- Photo detector and preamplifier in one package
- Internal filter for PCM frequency
- Supply voltage range: 2.5 V to 5.5 V
- Improved immunity against modulated light sources
- Insensitive to supply voltage ripple and noise
- Taping available for topview and sideview assembly
- Material categorization: For definitions of compliance please see [www.vishay.com/doc?99912](http://www.vishay.com/doc?99912)



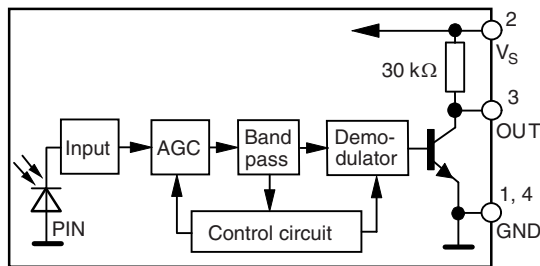
### DESCRIPTION

The TSOP75D26 is an SMD IR receiver module for 3D synchronisation signals. The receiver is designed to operate at a carrier frequency of 26.2 kHz and a wavelength of 830 nm to avoid interference with standard remote control systems at 940 nm and 30 kHz to 56 kHz. The TSOP75D26 can receive continuously transmitted signal patterns with a minimum burst length of 6 cycles and frame rates up to 200 Hz. The circuit provides good suppression of optical noise from CFLs, LCD backlight, and plasma panels.

### PARTS TABLE

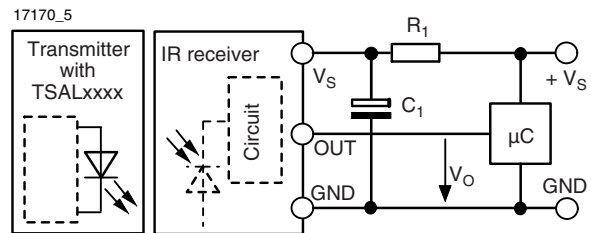
CARRIER FREQUENCY	GOOD NOISE SUPPRESSION AND FAST BURST RATE
26.2 kHz	TSOP75D26

### BLOCK DIAGRAM



20445-1

### APPLICATION CIRCUIT



$R_1$  and  $C_1$  are recommended for protection against EOS. Components should be in the range of  $33 \Omega < R_1 < 1 \text{ k}\Omega$ ,  $C_1 > 0.1 \mu\text{F}$ .

**ABSOLUTE MAXIMUM RATINGS**

PARAMETER	TEST CONDITION	SYMBOL	VALUE	UNIT
Supply voltage (pin 2)		$V_S$	- 0.3 to + 6	V
Supply current (pin 2)		$I_S$	3	mA
Output voltage (pin 3)		$V_O$	- 0.3 to ( $V_S + 0.3$ )	V
Output current (pin 3)		$I_O$	5	mA
Junction temperature		$T_j$	100	°C
Storage temperature range		$T_{stg}$	- 25 to + 85	°C
Operating temperature range		$T_{amb}$	- 25 to + 85	°C
Power consumption	$T_{amb} \leq 85\text{ °C}$	$P_{tot}$	10	mW

**Note**

- Stresses beyond those listed under “Absolute Maximum Ratings” may cause permanent damage to the device. This is a stress rating only and functional operation of the device at these or any other conditions beyond those indicated in the operational sections of this specification is not implied. Exposure to absolute maximum rating conditions for extended periods may affect the device reliability.

**ELECTRICAL AND OPTICAL CHARACTERISTICS** ( $T_{amb} = 25\text{ °C}$ , unless otherwise specified)

PARAMETER	TEST CONDITION	SYMBOL	MIN.	TYP.	MAX.	UNIT
Supply current (pin 2)	$E_v = 0, V_S = 3.3\text{ V}$	$I_{SD}$	0.27	0.35	0.45	mA
	$E_v = 40\text{ klx, sunlight}$	$I_{SH}$		0.45		mA
Supply voltage		$V_S$	2.5		5.5	V
Transmission distance	$E_v = 0$ , test signal see fig. 1, IR diode TSAL6200, $I_F = 250\text{ mA}$	$d$		45		m
Output voltage low (pin 3)	$I_{OSL} = 0.5\text{ mA}$ , $E_e = 0.7\text{ mW/m}^2$ , test signal see fig. 1	$V_{OSL}$			100	mV
Minimum irradiance	Pulse width tolerance: $t_{pi} - 80\text{ }\mu\text{s} < t_{po} < t_{pi} + 160\text{ }\mu\text{s}$ , test signal see fig. 1	$E_e\text{ min.}$		0.15	0.35	$\text{mW/m}^2$
Maximum irradiance	$t_{pi} - 80\text{ }\mu\text{s} < t_{po} < t_{pi} + 160\text{ }\mu\text{s}$ , test signal see fig. 1	$E_e\text{ max.}$	30			$\text{W/m}^2$
Directivity	Angle of half transmission distance	$\phi_{1/2}$		$\pm 50$		deg

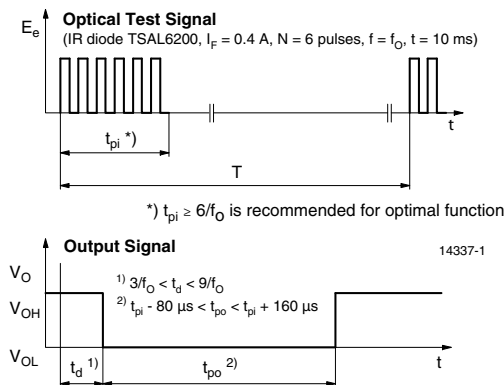
**TYPICAL CHARACTERISTICS** ( $T_{amb} = 25\text{ °C}$ , unless otherwise specified)


Fig. 1 - Output Active Low

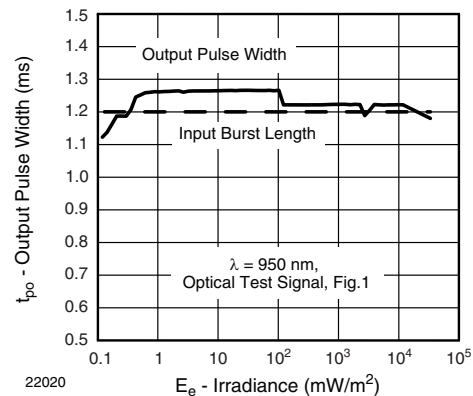


Fig. 2 - Pulse Length and Sensitivity in Dark Ambient

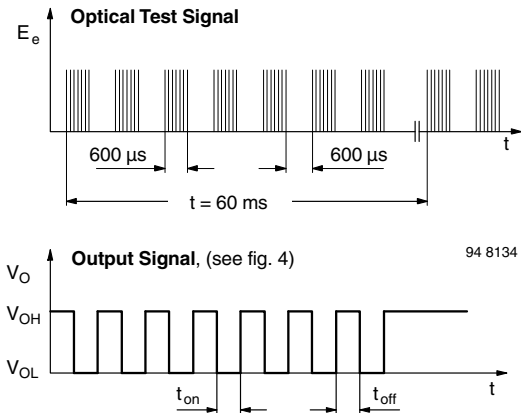


Fig. 3 - Output Function

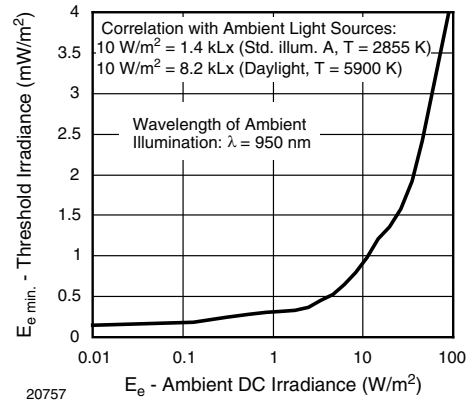


Fig. 6 - Sensitivity in Bright Ambient

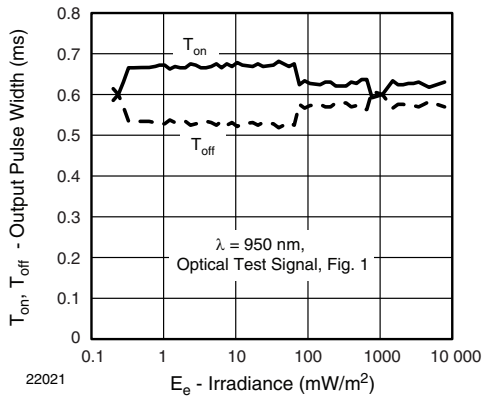


Fig. 4 - Output Pulse Diagram

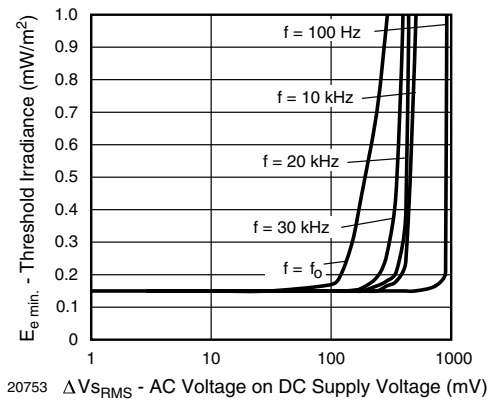


Fig. 7 - Sensitivity vs. Supply Voltage Disturbances

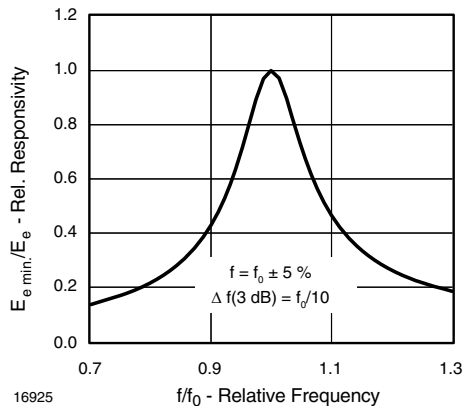


Fig. 5 - Frequency Dependence of Responsivity

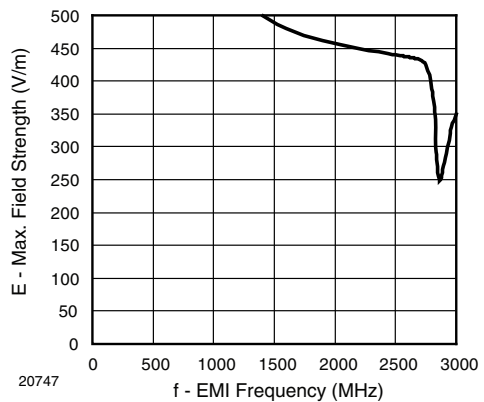


Fig. 8 - Sensitivity vs. Electric Field Disturbances

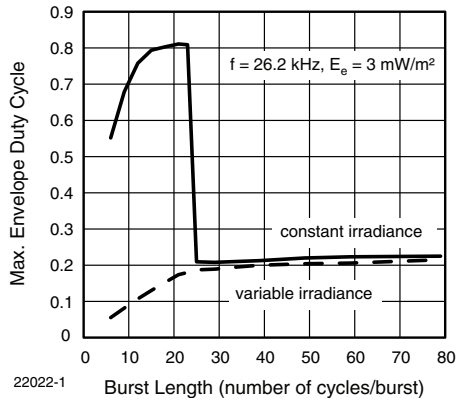
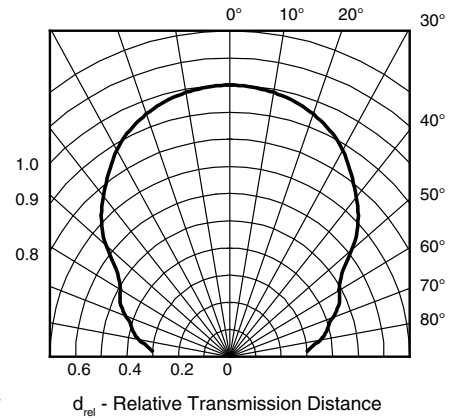
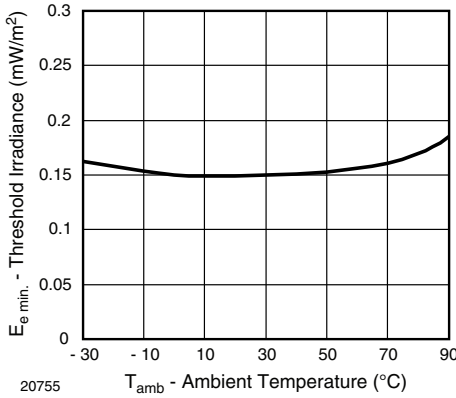


Fig. 9 - Maximum Envelope Duty Cycle vs. Burst Length



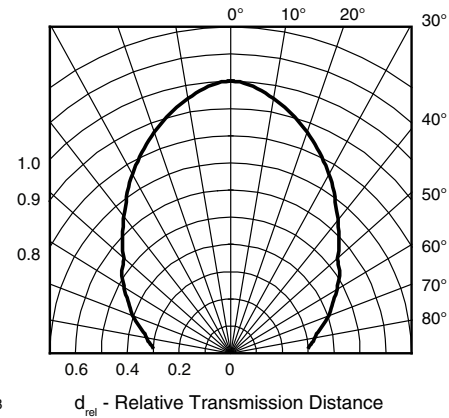
21427

Fig. 12 - Horizontal Directivity



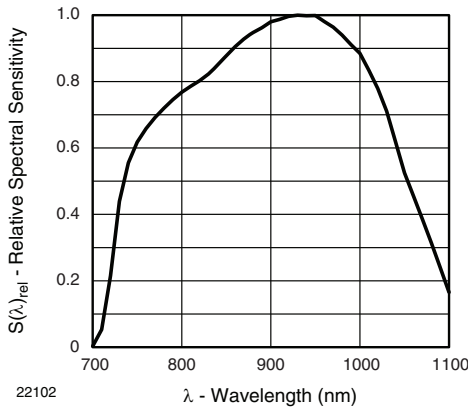
20755

Fig. 10 - Sensitivity vs. Ambient Temperature



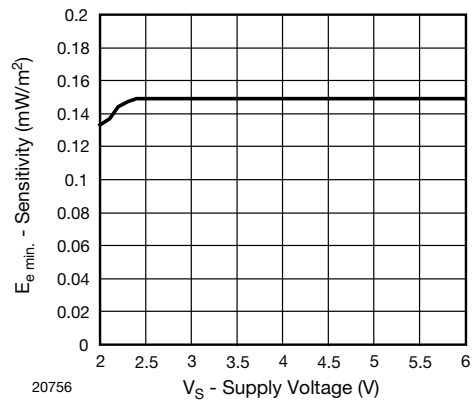
21428

Fig. 13 - Vertical Directivity



22102

Fig. 11 - Relative Spectral Sensitivity vs. Wavelength



20756

Fig. 14 - Sensitivity vs. Supply Voltage

Besides conformity to CEA-2038, please note the additional information:

### SUITABLE DATA FORMAT

The TSOP75D26 is designed to suppress spurious output pulses due to noise or disturbance signals. Data and disturbance signals can be distinguished by the devices according to carrier frequency, burst length and envelope duty cycle. The data signal should be close to the band-pass center frequency (e.g. 26.2 kHz) and fulfill the conditions in the table below.

When a data signal is applied to the TSOP75D26 in the presence of a disturbance signal, the sensitivity of the receiver is reduced to insure that no spurious pulses are present at the output. Some examples of disturbance signals which are suppressed are

- DC light (e.g. from tungsten bulb or sunlight)
- Continuous signals at any frequency
- Strongly or weakly modulated noise from fluorescent lamps with electronic ballasts (see figure 15 or figure 16)

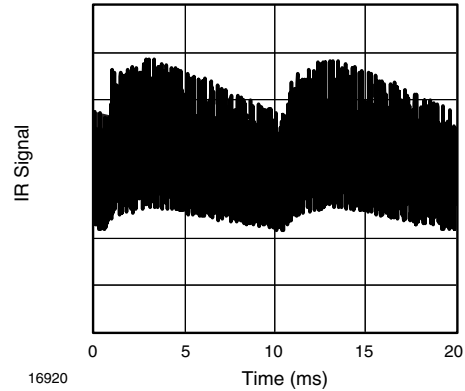


Fig. 15 - IR Signal from Fluorescent Lamp with Low Modulation

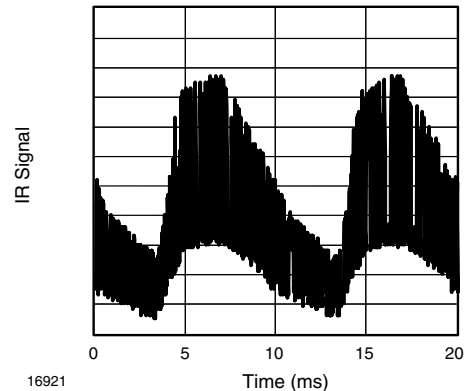


Fig. 16 - IR Signal from Fluorescent Lamp with High Modulation

	<b>TSOP75D26</b>
Minimum burst length	6 cycles/burst
After each burst of length a minimum gap time is required of	6 to 24 cycles ≥ 6 cycles
For bursts greater than a minimum gap time in the data stream is needed of	24 cycles > 4 x burst length
Maximum rate of short bursts (constant irradiance)	2000 bursts/s
Maximum rate of short bursts (variable irradiance)	220 bursts/s

Please note: The CEA-2038 standard includes no provision for a power down scheme.

### STAND-BY MODE OF THE TSOP75D26

If an application requires an ultra low average supply current in order to save battery life, the TSOP75D26 can be operated with an intermittent supply voltage. A typical application circuit shown in fig. 17.

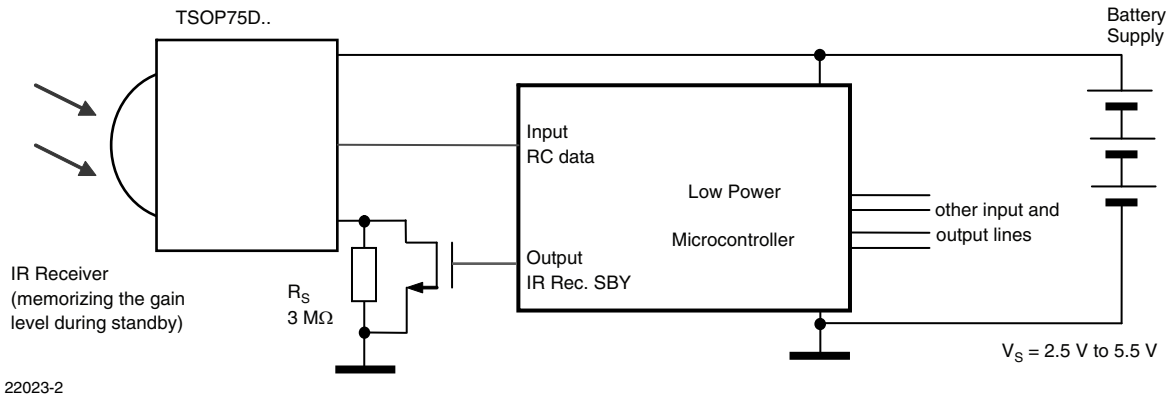


Fig. 17 - Application Circuit for the TSOP75D26 with Intermittent Supply Voltage

To receive a continuous data signal while using the TSOP75D26 with an intermittent supply voltage, the receiver must be activated in advance of the expected data frame as shown in figure 18.

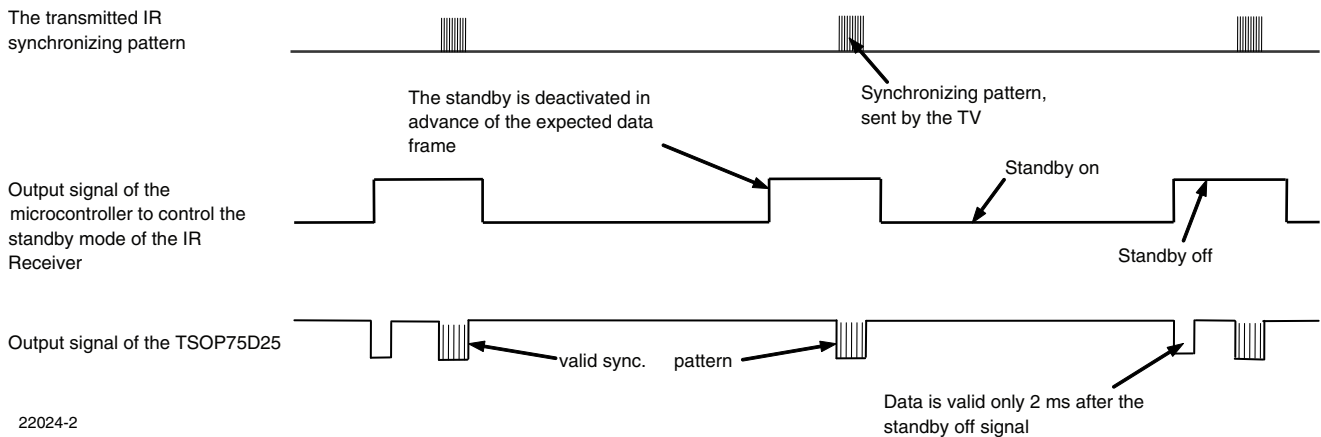


Fig. 18 - Signal Timing in Power Saving Mode with Continuous Receiving Function

In normal operation without using the stand-by feature, the gain level of the TSOP75D26 returns to a default level after the device is disconnected from supply voltage and reconnected again. A settling time of up to 100 ms is necessary until the gain has settled to an optimum level that is well matched to the ambient noise level.

Using the device in stand-by mode, the TSOP75D26 memorizes its gain setting while in standby. On re-activation, the gain immediately returns to the correct level present before stand-by. This operation insures that there are no spurious pulses on power-up due to mismatch between the gain level and the ambient light conditions.

**ELECTRICAL AND OPTICAL CHARACTERISTICS** ( $T_{amb} = 25\text{ }^{\circ}\text{C}$ , unless otherwise specified)

PARAMETER	TEST CONDITION	SYMBOL	MIN.	TYP.	MAX.	UNIT
Serial resistor to activate the standby mode	$V_S = 3\text{ V}$	$R_S$	1.2	1.5	2	$M\Omega$
	$V_S = 5\text{ V}$	$R_S$	2	3	4	
Standby supply current	$V_S = 3\text{ V}$ , $R_S = 1.5\text{ M}\Omega$	$I_{SBY}$	1	1.4	2	$\mu\text{A}$
	$V_S = 5\text{ V}$ , $R_S = 3\text{ M}\Omega$	$I_{SBY}$	1	1.4	2	
Latency time for standby-off (delay until there is a valid response)	$V_S > 2.5\text{ V}$ , dark ambient, output is valid	$t_{delay}$		0.4	0.8	ms
	$V_S > 2.5\text{ V}$ , 10 klx daylight, output is valid	$t_{delay}$		1.5	2.5	
Duration of standby-off period	$V_S > 2.5\text{ V}$ , dark ambient	$t_{SBY\_OFF}$	1			ms
	$V_S > 2.5\text{ V}$ , 10 klx daylight, AGC1 or AGC3 device	$t_{SBY\_OFF}$	4			
	$V_S > 2.5\text{ V}$ , 10 klx daylight, AGC2 or AGC4 device	$t_{SBY\_OFF}$	3			

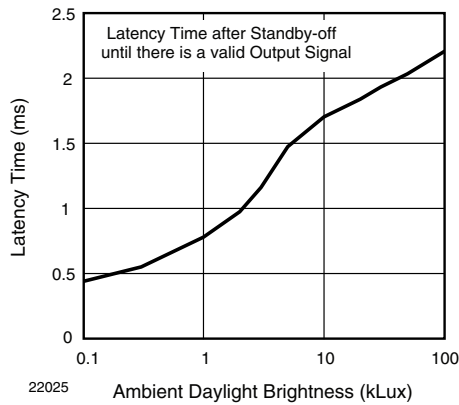
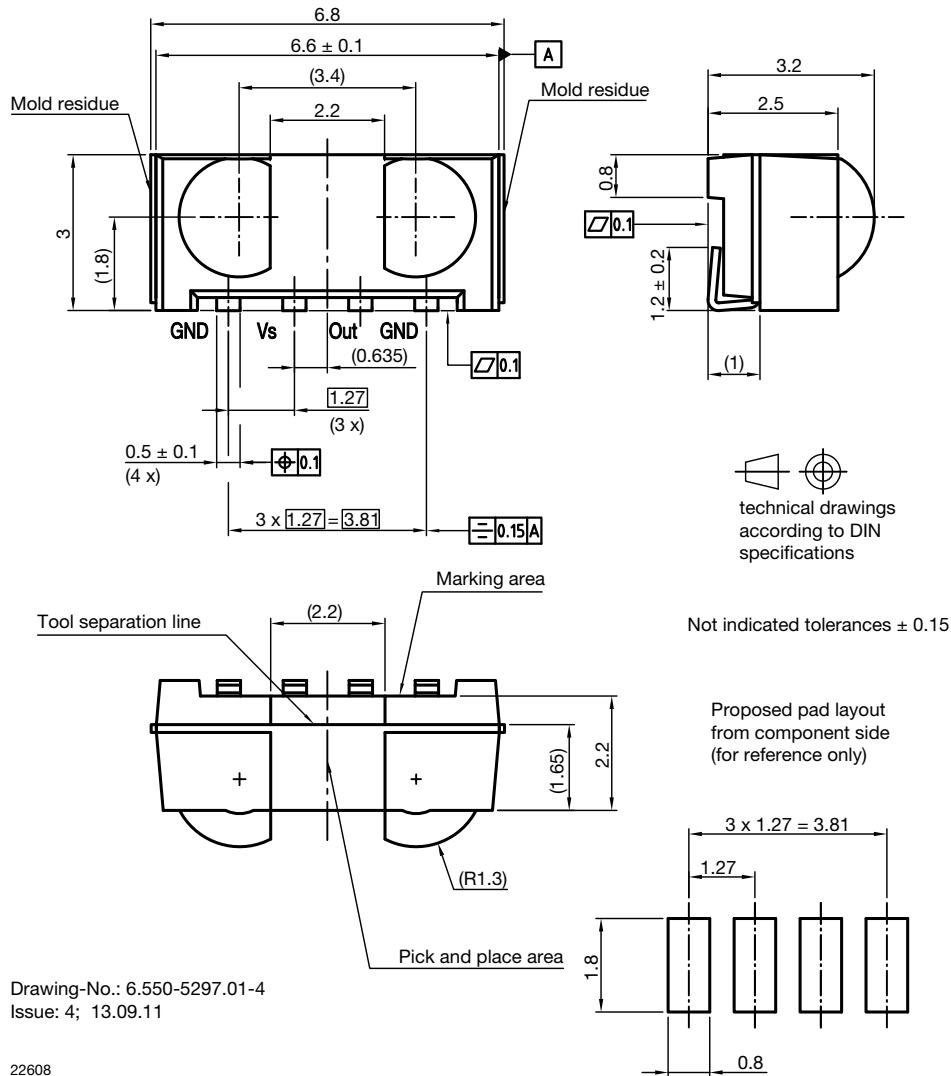
**TYPICAL CHARACTERISTICS** ( $T_{amb} = 25\text{ }^{\circ}\text{C}$ , unless otherwise specified)


Fig. 19 - Delay Time after Standby-off until the TSOP75D26 is ready to receive Data

**PACKAGE DIMENSIONS** in millimeters



**ASSEMBLY INSTRUCTIONS**

**Reflow Soldering**

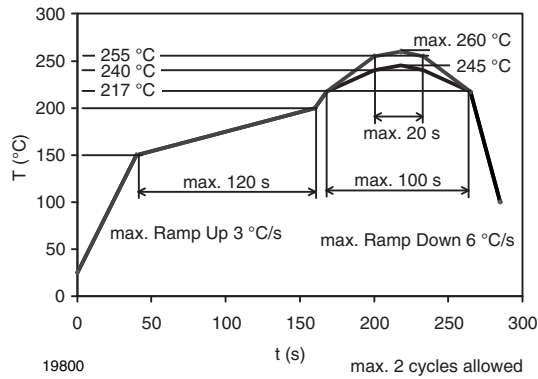
- Reflow soldering must be done within 72 h while stored under a max. temperature of 30 °C, 60 % RH after opening the dry pack envelope
- Set the furnace temperatures for pre-heating and heating in accordance with the reflow temperature profile as shown in the diagram. Exercise extreme care to keep the maximum temperature below 260 °C. The temperature shown in the profile means the temperature at the device surface. Since there is a temperature difference between the component and the circuit board, it should be verified that the temperature of the device is accurately being measured
- Handling after reflow should be done only after the work surface has been cooled off

**Manual Soldering**

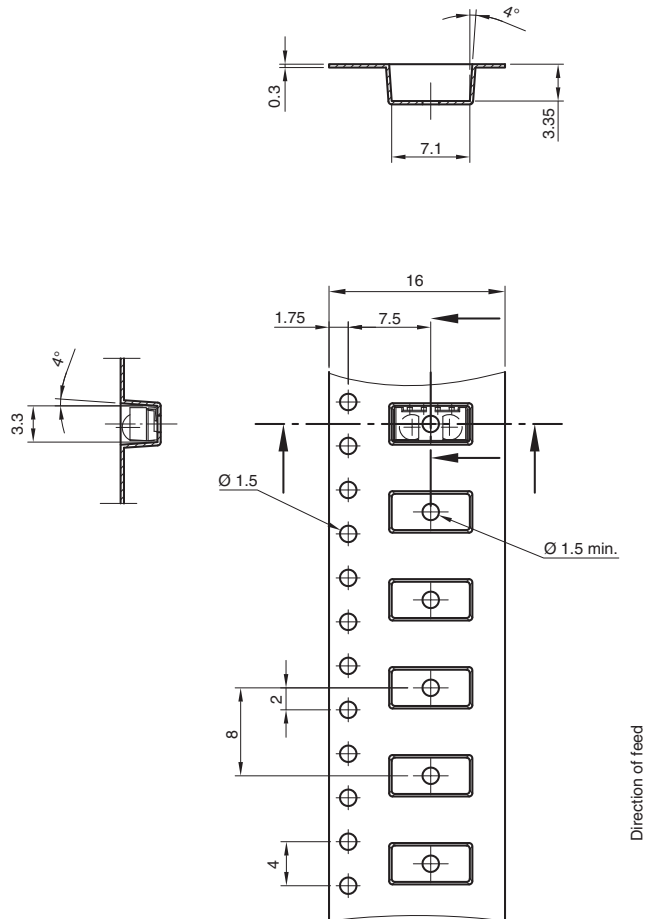
- Use a soldering iron of 25 W or less. Adjust the temperature of the soldering iron below 300 °C
- Finish soldering within 3 s
- Handle products only after the temperature has cooled off



## VISHAY LEAD (Pb)-FREE REFLOW SOLDER PROFILE



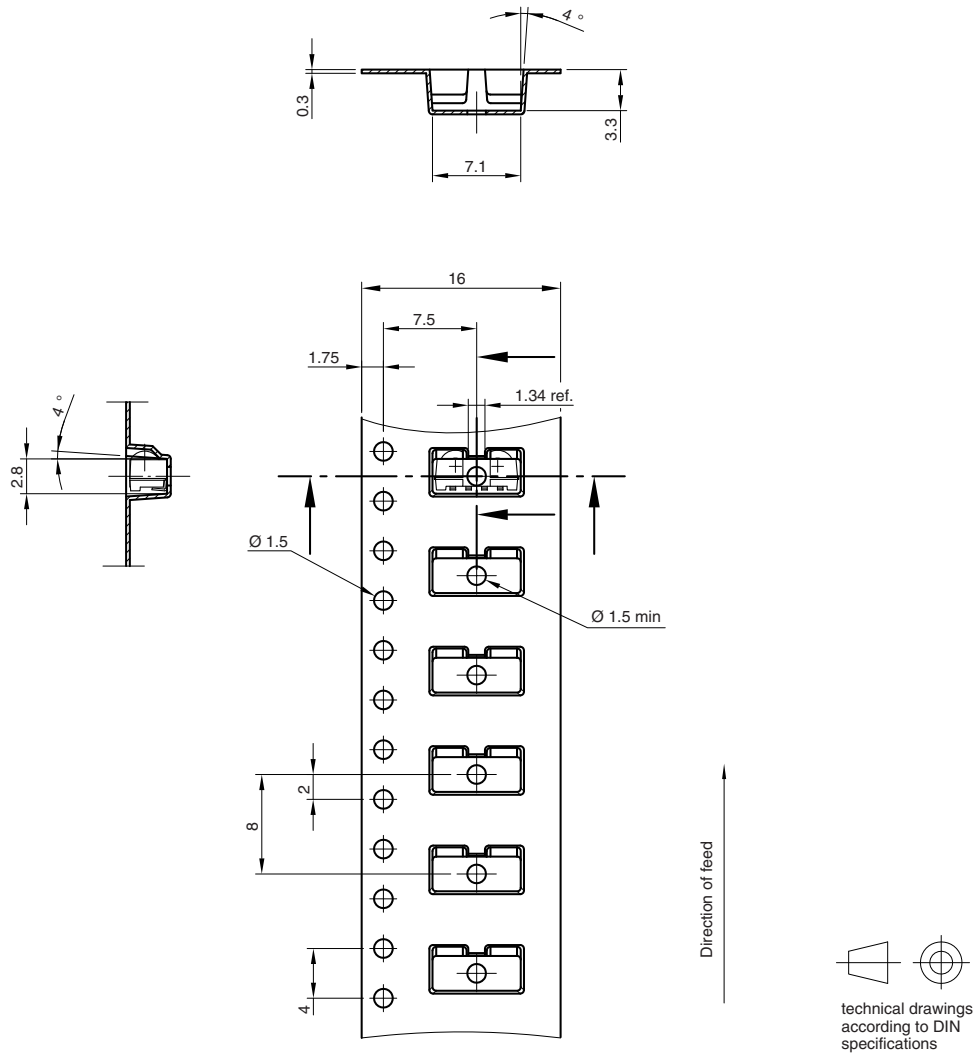
## TAPING VERSION TSOP..TT DIMENSIONS in millimeters



Drawing-No.: 9.700-5338.01-4  
 Issue: 3; 09.06.09  
 21578

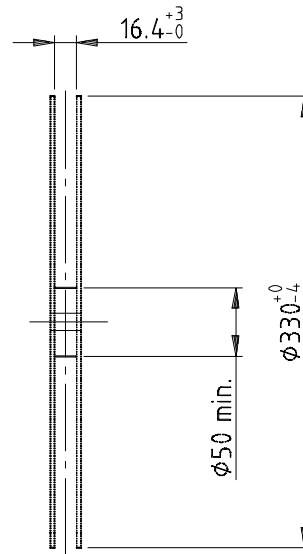
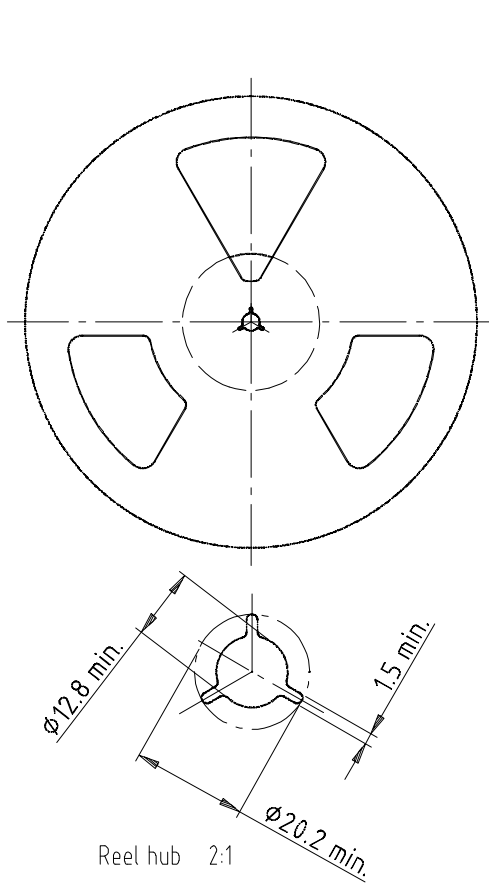
technical drawings  
 according to DIN  
 specifications

## TAPING VERSION TSOP..TR DIMENSION in millimeters



Drawing-No.: 9.700-5337.01-4  
 Issue: 1; 16.10.08  
 21577

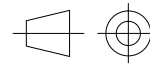
**REEL DIMENSIONS** in millimeters



Form of the leave open of the wheel is supplier specific.

Dimension acc. to IEC EN 60 286-3

Tape width 16



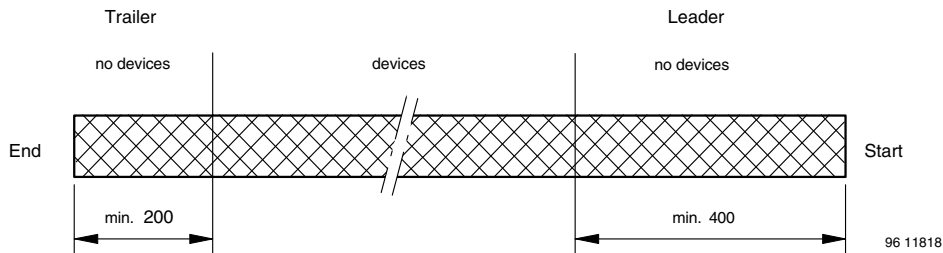
technical drawings according to DIN specifications

Drawing-No.: 9.800-5052.V2-4

Issue: 1; 07.05.02

16734

**LEADER AND TRAILER DIMENSIONS** in millimeters



**COPER TAPE PEEL STRENGTH**

According to DIN EN 60286-3  
 0.1 N to 1.3 N  
 300 mm/min.  $\pm$  10 mm/min.  
 165° to 180° peel angle

**LABEL**

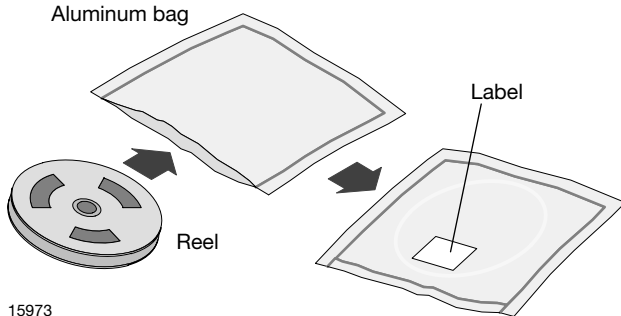
**Standard bar code labels for finished goods**

The standard bar code labels are product labels and used for identification of goods. The finished goods are packed in final packing area. The standard packing units are labeled with standard bar code labels before transported as finished goods to warehouses. The labels are on each packing unit and contain Vishay Semiconductor GmbH specific data.

VISHAY SEMICONDUCTOR GmbH STANDARD BAR CODE PRODUCT LABEL (finished goods)		
PLAIN WRITTING	ABBREVIATION	LENGTH
Item-description	-	18
Item-number	INO	8
Selection-code	SEL	3
LOT-/serial-number	BATCH	10
Data-code	COD	3 (YWW)
Plant-code	PTC	2
Quantity	QTY	8
Accepted by	ACC	-
Packed by	PCK	-
Mixed code indicator	MIXED CODE	-
Origin	xxxxxxx+	Company logo
LONG BAR CODE TOP	TYPE	LENGTH
Item-number	N	8
Plant-code	N	2
Sequence-number	X	3
Quantity	N	8
Total length	-	21
SHORT BAR CODE BOTTOM	TYPE	LENGTH
Selection-code	X	3
Data-code	N	3
Batch-number	X	10
Filter	-	1
Total length	-	17

**DRY PACKING**

The reel is packed in an anti-humidity bag to protect the devices from absorbing moisture during transportation and storage.



**FINAL PACKING**

The sealed reel is packed into a cardboard box. A secondary cardboard box is used for shipping purposes.

**RECOMMENDED METHOD OF STORAGE**

Dry box storage is recommended as soon as the aluminum bag has been opened to prevent moisture absorption. The following conditions should be observed, if dry boxes are not available:

- Storage temperature 10 °C to 30 °C
- Storage humidity ≤ 60 % RH max.

After more than 72 h under these conditions moisture content will be too high for reflow soldering.

In case of moisture absorption, the devices will recover to the former condition by drying under the following condition:  
 192 h at 40 °C + 5 °C/- 0 °C and < 5 % RH (dry air/nitrogen) or  
 96 h at 60 °C + 5 °C and < 5 % RH for all device containers or  
 24 h at 125 °C + 5 °C not suitable for reel or tubes.

An EIA JEDEC standard JSTD-020 level 4 label is included on all dry bags.

**CAUTION**  
This bag contains  
**MOISTURE-SENSITIVE DEVICES**

**LEVEL**  
**4**

1. Shelf life in sealed bag: 12 months at < 40 °C and < 90 % relative humidity (RH)
2. After this bag is opened, devices that will be subjected to soldering reflow or equivalent processing (peak package body temp. 260 °C) must be
  - 2a. Mounted within 72 hours at factory condition of < 30 °C/60 % RH or
  - 2b. Stored at < 5 % RH
3. Devices require baking before mounting if:  
Humidity Indicator Card is > 10 % when read at 23 °C ± 5 °C or 2a. or 2b. are not met.
4. If baking is required, devices may be baked for:  
192 hours at 40 °C + 5 °C/- 0 °C and < 5 % RH (dry air/nitrogen) or  
96 hours at 60 °C ± 5 °C and < 5 % RH for all device containers or  
24 hours at 125 °C ± 5 °C not suitable for reels or tubes

Bag Seal Date: \_\_\_\_\_  
(If blank, see barcode label)

Note: Level and body temperature defined by EIA JEDEC Standard JSTD-020

22522

EIA JEDEC standard JSTD-020 level 4 label is included on all dry bags

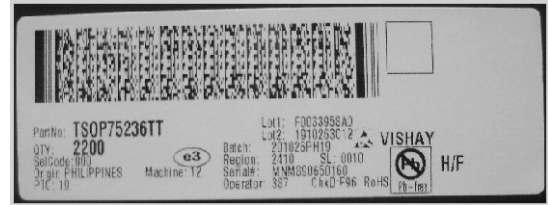


**ESD PRECAUTION**

Proper storage and handling procedures should be followed to prevent ESD damage to the devices especially when they are removed from the antistatic shielding bag. Electro-static sensitive devices warning labels are on the packaging.

**VISHAY SEMICONDUCTORS STANDARD BAR CODE LABELS**

The Vishay Semiconductors standard bar code labels are printed at final packing areas. The labels are on each packing unit and contain Vishay Semiconductors specific data.



22178



## Disclaimer

ALL PRODUCT, PRODUCT SPECIFICATIONS AND DATA ARE SUBJECT TO CHANGE WITHOUT NOTICE TO IMPROVE RELIABILITY, FUNCTION OR DESIGN OR OTHERWISE.

Vishay Intertechnology, Inc., its affiliates, agents, and employees, and all persons acting on its or their behalf (collectively, "Vishay"), disclaim any and all liability for any errors, inaccuracies or incompleteness contained in any datasheet or in any other disclosure relating to any product.

Vishay makes no warranty, representation or guarantee regarding the suitability of the products for any particular purpose or the continuing production of any product. To the maximum extent permitted by applicable law, Vishay disclaims (i) any and all liability arising out of the application or use of any product, (ii) any and all liability, including without limitation special, consequential or incidental damages, and (iii) any and all implied warranties, including warranties of fitness for particular purpose, non-infringement and merchantability.

Statements regarding the suitability of products for certain types of applications are based on Vishay's knowledge of typical requirements that are often placed on Vishay products in generic applications. Such statements are not binding statements about the suitability of products for a particular application. It is the customer's responsibility to validate that a particular product with the properties described in the product specification is suitable for use in a particular application. Parameters provided in datasheets and/or specifications may vary in different applications and performance may vary over time. All operating parameters, including typical parameters, must be validated for each customer application by the customer's technical experts. Product specifications do not expand or otherwise modify Vishay's terms and conditions of purchase, including but not limited to the warranty expressed therein.

Except as expressly indicated in writing, Vishay products are not designed for use in medical, life-saving, or life-sustaining applications or for any other application in which the failure of the Vishay product could result in personal injury or death. Customers using or selling Vishay products not expressly indicated for use in such applications do so at their own risk. Please contact authorized Vishay personnel to obtain written terms and conditions regarding products designed for such applications.

No license, express or implied, by estoppel or otherwise, to any intellectual property rights is granted by this document or by any conduct of Vishay. Product names and markings noted herein may be trademarks of their respective owners.

## Material Category Policy

**Vishay Intertechnology, Inc. hereby certifies that all its products that are identified as RoHS-Compliant fulfill the definitions and restrictions defined under Directive 2011/65/EU of The European Parliament and of the Council of June 8, 2011 on the restriction of the use of certain hazardous substances in electrical and electronic equipment (EEE) - recast, unless otherwise specified as non-compliant.**

**Please note that some Vishay documentation may still make reference to RoHS Directive 2002/95/EC. We confirm that all the products identified as being compliant to Directive 2002/95/EC conform to Directive 2011/65/EU.**

**Vishay Intertechnology, Inc. hereby certifies that all its products that are identified as Halogen-Free follow Halogen-Free requirements as per JEDEC JS709A standards. Please note that some Vishay documentation may still make reference to the IEC 61249-2-21 definition. We confirm that all the products identified as being compliant to IEC 61249-2-21 conform to JEDEC JS709A standards.**